

JB SANITARY

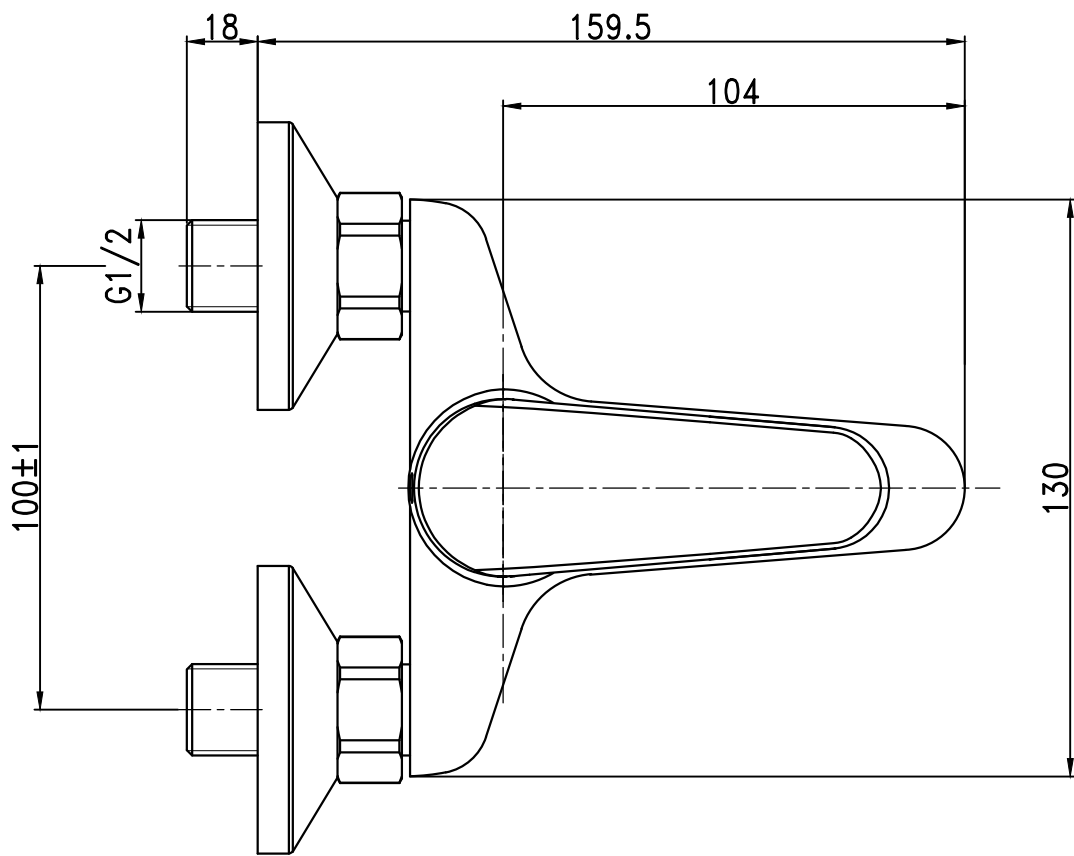
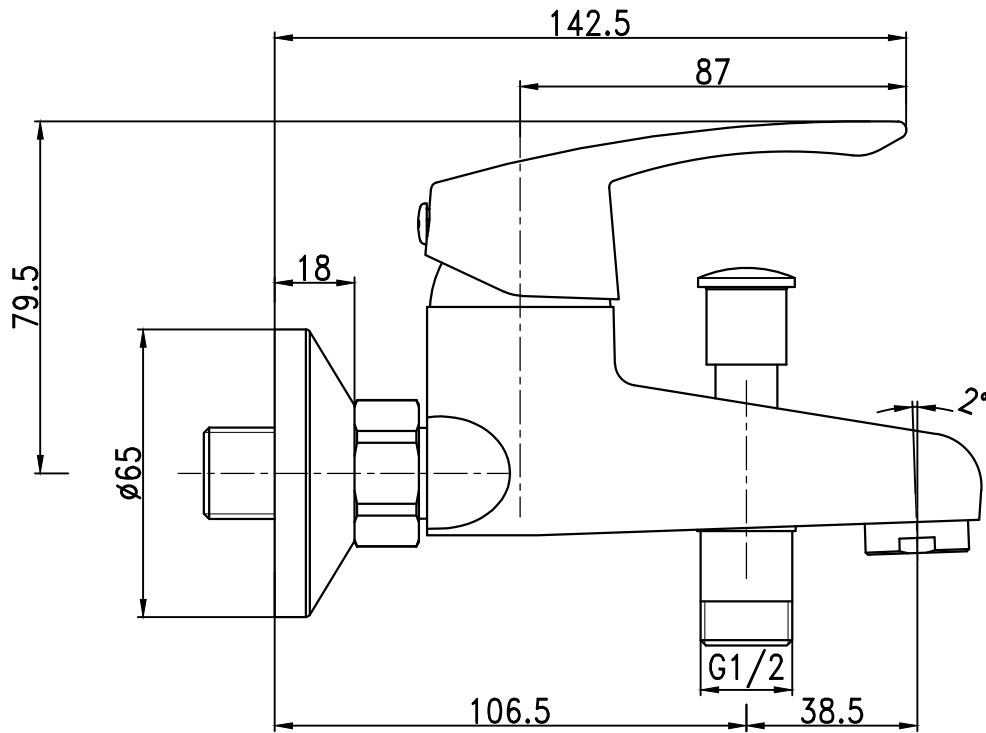

L10 45 00